

TOWER GARDEN ASSEMBLY INSTRUCTIONS

IT TOWER GARDEN - ISTRUZIONI DI MONTAGGIO

ES TOWER GARDEN - INSTRUCCIONES DE MONTAJE

FR TOWER GARDEN - INSTRUCTIONS DE MONTAGE

NL TOWER GARDEN - MONTAGE-INSTRUCTIES

PL TOWER GARDEN - INSTRUKCJE SKŁADANIA

DE TOWER GARDEN - MONTAGEANLEITUNGEN

NO TOWER GARDEN - MONTERINGSANVISNINGER

SE TOWER GARDEN - MONTERINGSANVISNINGAR

FI TOWER GARDEN - KOKOAMISOHJEET

DK TOWER GARDEN - MONTERINGSVEJLEDNING

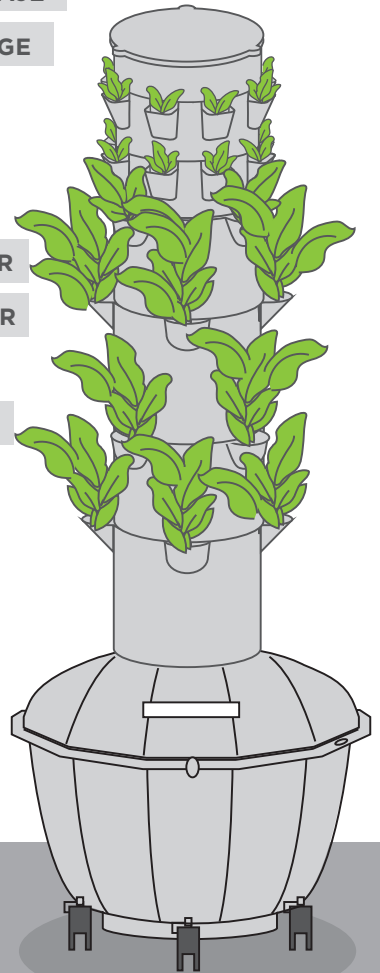

EN Symbols IT Descrizione dei simboli ES Símbolos FR Symboles

NL Symbolen PL Objaśnienie symboli DE Symbolerklärung NO Symboler

SE Symboler FI Symbolit DK Symboler



EN TIGHTLY FITTING GOGGLES
IT OCCHIALI DI PROTEZIONE A MASCHERINA
ES GAFAS DE SEGURIDAD BIEN AJUSTADAS
FR LUNETTES DE SÉCURITÉ ÉTANCHES
NL STRAK AANSLUITENDE VEILIGHEIDSBRIL
PL DOPASOWANE OKULARY OCHRONNE
DE DICHTSCHLIESSENDE SCHUTZBRILLE
NO TETTSITTENDE VERNEBRILLER
SE TÄTTLUTANDE SKYDDSGLASÖGON
FI TIIVIIT SUOJALASIT
DK TÆTTSIDDENDE BESKYTTELSESRILLER



EN PROTECTIVE GLOVES
IT GUANTI DI PROTEZIONE
ES GUANTES DE PROTECCIÓN
FR GANTS DE PROTECTION
NL VEILIGHEIDSHANDSCHOENEN
PL REKAWICE OCHRONNE
DE SCHUTZHANDSCHUHE
NO VERNEHANSKER
SE SKYDDSHANDSKAR
FI SUOJAKÄSINEET
DK BESKYTTELSESHANDSKER



EN PLEASE NOTE
IT NOTA BENE
ES PRESTE ATENCIÓN
FR VEUILLEZ NOTER
NL OPGELET
PL UWAGA
DE BITTE BEACHTEN
NO MERK
SE OBS!
FI HUOMAA
DK BEMÆRK



EN HARMFUL
IT NOCIVO
ES PERJUDICIAL PARA LA SALUD
FR DANGEREUX À LONG TERME
NL SCHADELIJK VOOR DE GEZONDHEID
PL SZKODLIWY
DE GESUNDHEITSSCHÄDIGEND
NO HELSESKADELIG
SE SKADLIG
FI HAITALLINEN
DK SKADELIG



EN CORROSIVITY
IT CORROSIVO
ES CORROSIVIDAD
FR CORROSIF
NL BIJTEND
PL KOROZYJNOŚĆ
DE ÄTZWIRKUNG
NO ETSENDE
SE FRÅTANDE
FI SYÖVYTTÄVÄ
DK ÆTSENDE



EN CAUTION DANGER
IT ATTENZIONE: PERICOLO!
ES PRECAUCIÓN PELIGRO
FR ATTENTION DANGER
NL VOORZICHTIG GEVAARLIJK
PL UWAGA, NIEBEZPIECZEŃSTWO!
DE VORSICHT GEFAHR
NO FORSIKTIG - FARE
SE FARA
FI VAROITUS VAARA
DK FORSIGTIG: FARE

1.

EN Set up IT Configurazione ES Configurar FR Montage

NL Installatie PL Montaż DE Einrichten NO Sett opp

SE Installera FI Perustaminen DK Opsætning

1.

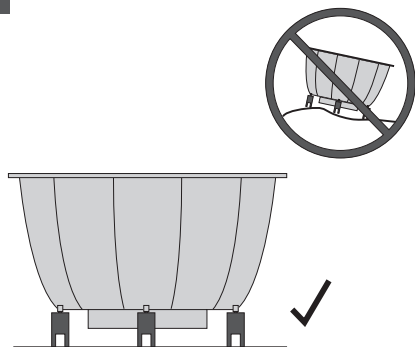

2.

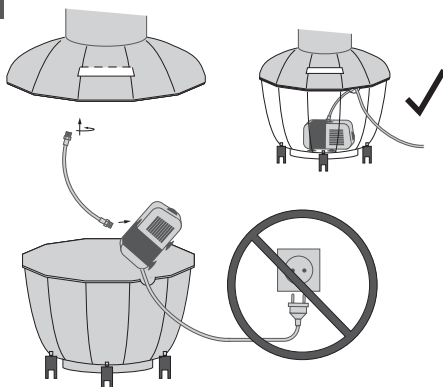

3.

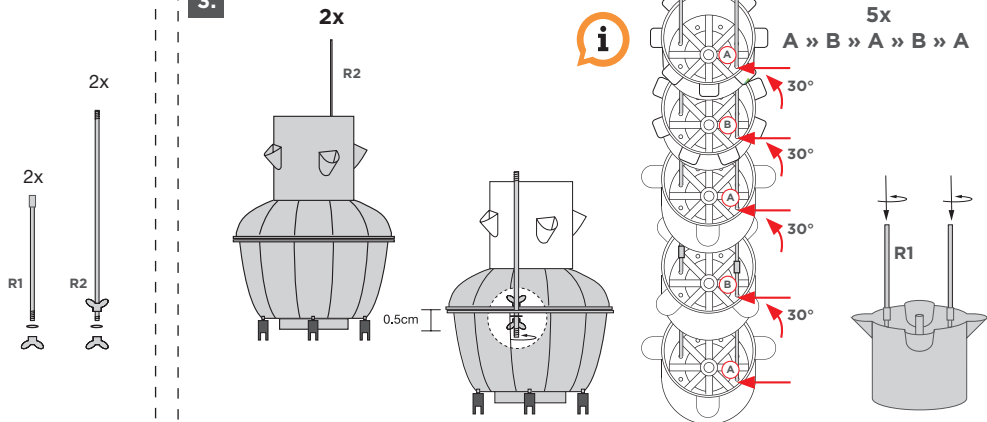

4.

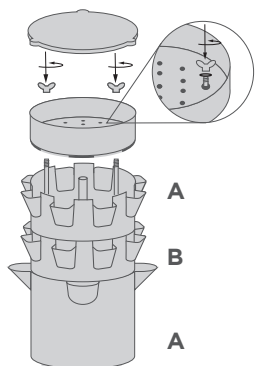

5.

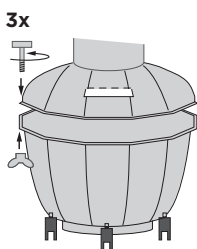

6.

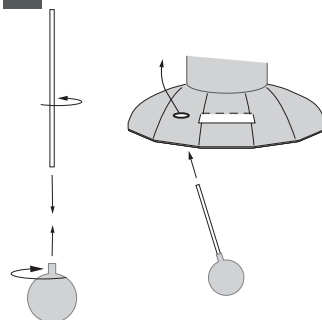

2.

EN Start growing IT Iniziare a coltivare ES Empieza a crecer FR Commencez à cultiver
 NL Beginnen met groeien PL Uprawa DE Mit der Anzucht beginnen
 NO Begynn å dyrke SE Börja odla FI Aloita kasvattaminen DK Begynd at vokse

1.

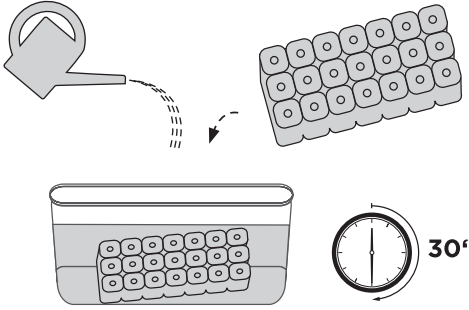

2.

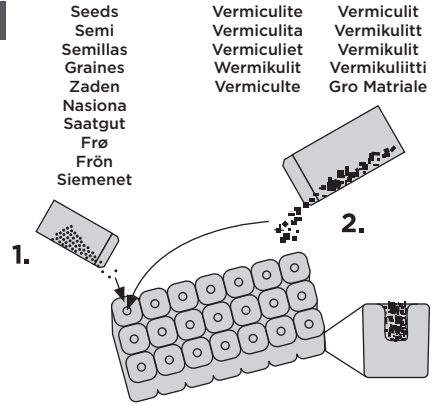

3.

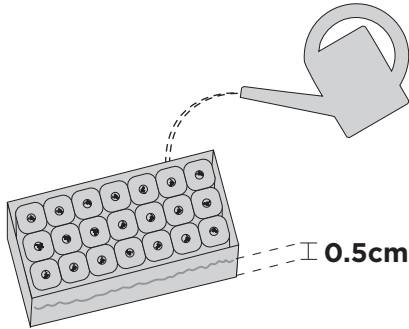

4.

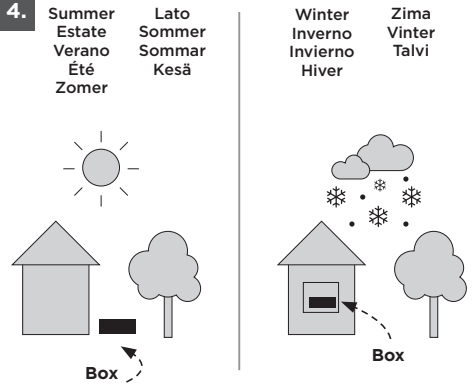

5.

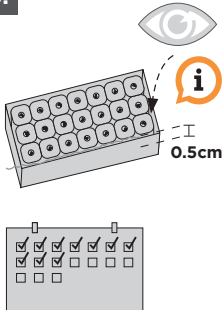

6.

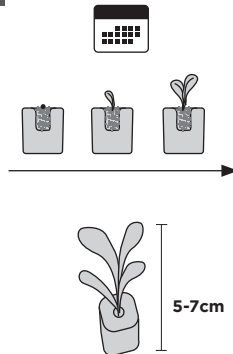

7.

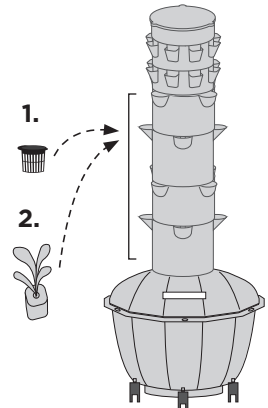

3.

EN Activation IT Attivazione ES Activación FR Activation
NL Activering PL Aktywacja DE Aktivierung NO Aktivisering
SE Aktivering FI Aktivointi DK Aktivering

1.

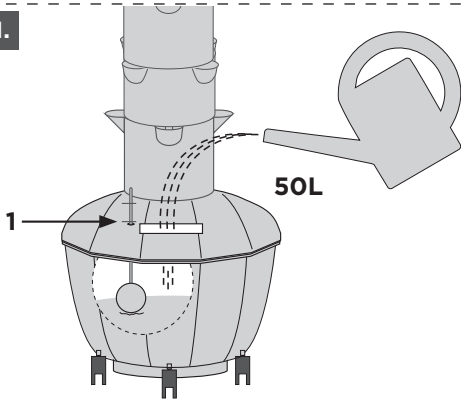

2.

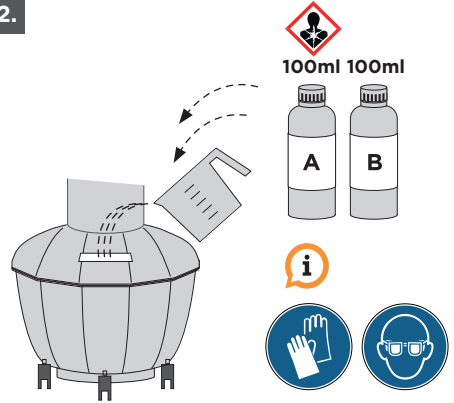

3.

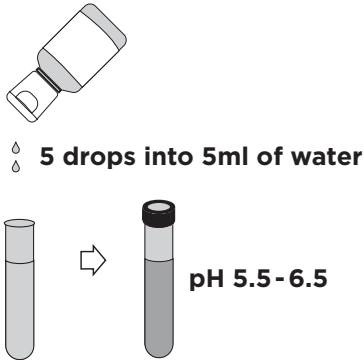

4.

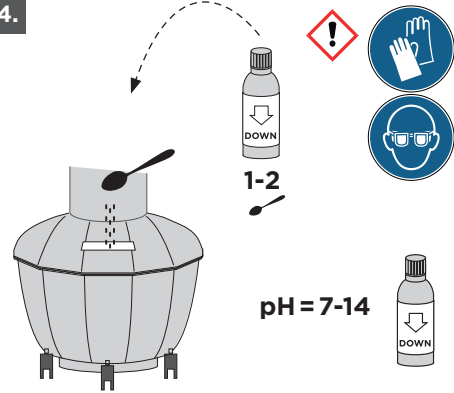

5.



outdoor | all'aperto | Exterior
à l'extérieur | buiten | na zewnątrz
im Freien | utendørs | utomhus
ulkona | udendørs:



indoor | al coperto | Interior
à l'intérieur | binnen | wewnątrz
Innenbereich | innendørs | inomhus
sisällä | indendørs:

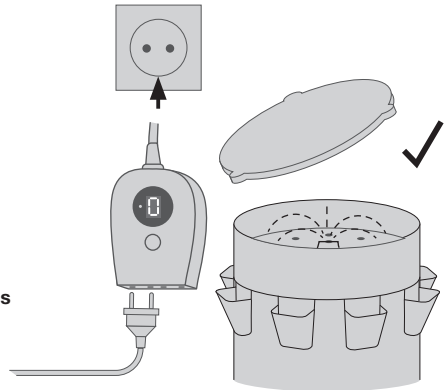

EN: pH-Check IT: Controllo del pH
 ES: Comprobación del pH
 FR: Contrôle du pH NL: pH-Check
 PL: Kontrola pH DE: ph-Check
 NO: pH-måling SE: pH-kontroll
 FI: pH-kontrolli DK: pH-Check

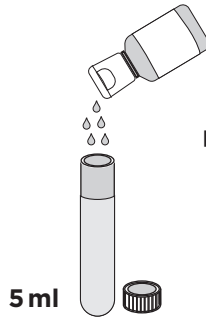
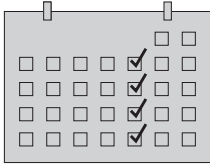

pH 5-6.5

pH = 7-14

→ 1-2



EN: Nutrition & Water IT: Nutrizione
 e acqua ES: Nutrición y agua
 FR: Nutrition et eau NL: Voeding &
 Water PL: Nawóz i woda
 DE: Nährstoffe & Wasser NO: Næring og
 vann SE: Näring och vatten FI: Ravinteen
 javesi DK: Ernæring & Vand

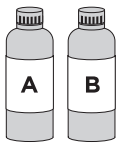
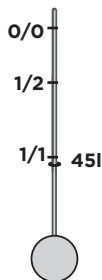
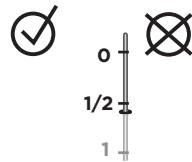
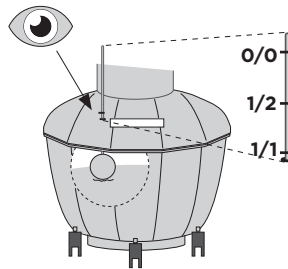
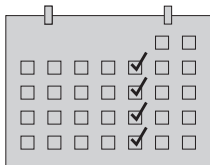

2ml/ 2ml/
1l 1l

EN: pH-Check IT: Controllo del pH
 ES: Comprobación del pH
 FR: Contrôle du pH NL: pH-Check
 PL: Kontrola pH DE: ph-Check
 NO: pH-måling SE: pH-kontroll
 FI: pH-kontrolli DK: pH-Check



EN: Cleaning IT: Pulizia ES: Limpieza
 FR: Nettoyage NL: Schoonmaken
 PL: Czyszczenie DE: Reinigung
 NO: Rengjøring SE: Rengöring
 FI: Puhdistus DK: Rengøring

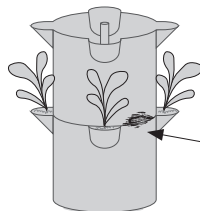

Vinegar
 Aceto
 Aceto
 Vinaigre
 Azijn
 Ocet

Essig
 Ättika
 Etikka
 Eddike

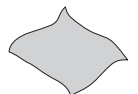

EN Emptying the reservoir IT Svuotare il serbatoio ES Vaciado del depósito
FR Vidange du réservoir NL Leegmaken van het reservoir PL Opróżnianie zbiornika
DE Entleeren des Behälters NO Tømmer reservoaret SE Tömning av behållaren
FI Säiliön tyhjentäminen DK Tømning af reservoiret

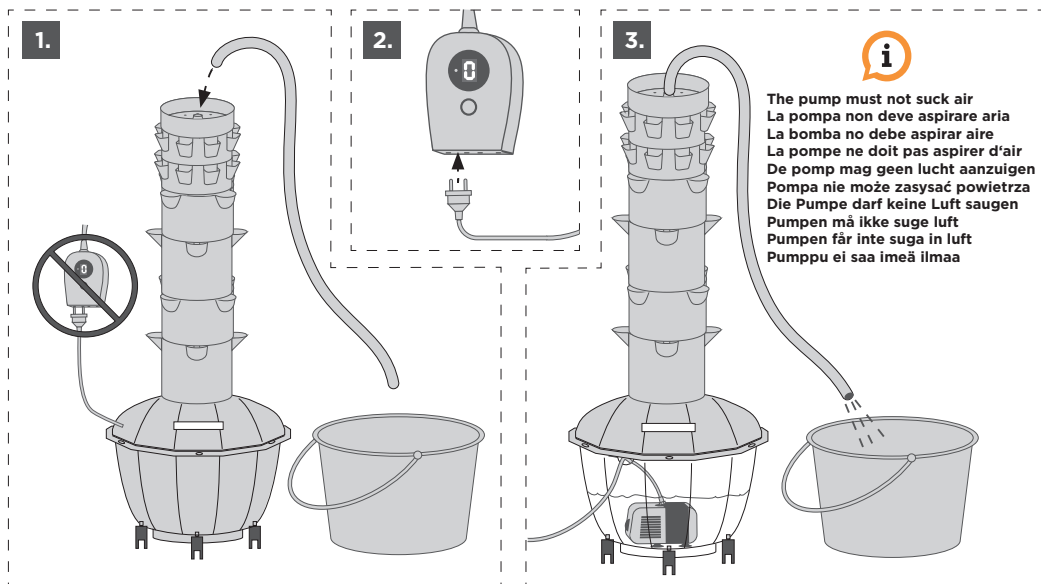

TOWER
GARDEN
BY JUICE PLUS+

towergardensupport.emea@juiceplus.com

